

FOUR ROLLER  
FAIRLEAD

# MODEL FR4-4

## STANDARD FEATURES

- Designed with a S.W.L. of 10MT (26,046 Lbs or 98.1 kN) per O.C.I.M.F. Rev.3 Guidelines.
- Hardened Rollers for Longer Life
- Grease Lubricated Bronze Bearings
- Epoxy Primer Coating

## OPTIONAL FEATURES

- Customized Design to Suit Your Application
- Seawater Lubricated Bearings for Underwater Use
- Bolt Down Mounting Base
- Stainless Steel Rollers
- Load Monitoring System
- Three Coat Marine Paint System
- Third Party Certification

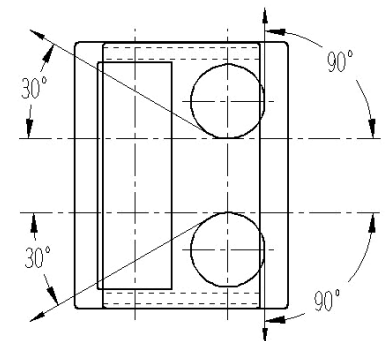
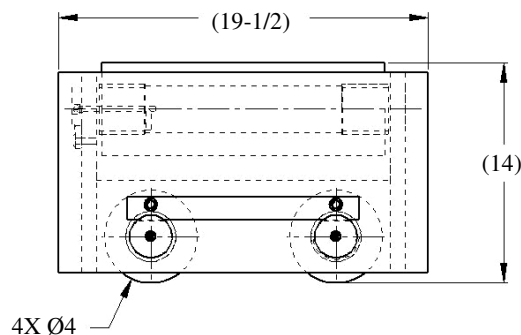

PLAN LOADING LIMITS

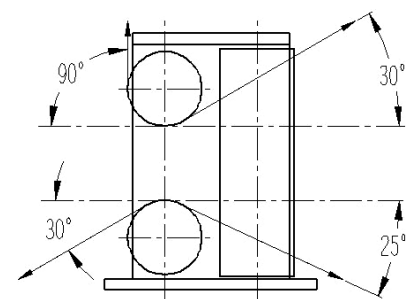
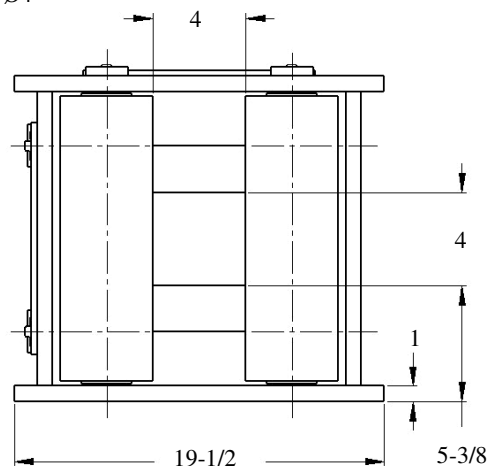
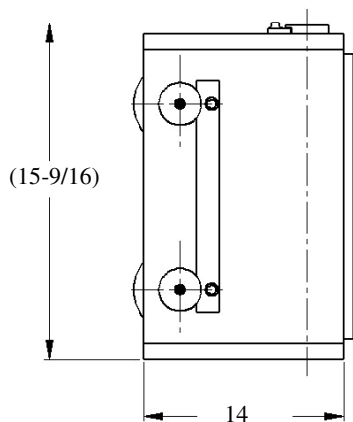

ELEVATION LOADING LIMITS

\* DIMENSIONS SUBJECT TO CHANGE WITHOUT NOTICE\*

WEIGHT: 360 LBS

**Smith Berger Marine, Inc. - Mooring & Towing Solutions**

7915 10<sup>th</sup> Ave. S., Seattle, WA 98108 USA

Tel. 206.764.4650 - Toll Free 888.726.1688 - Fax 206.764.4653

E-mail: [sales@smithberger.com](mailto:sales@smithberger.com) - Web: [www.smithberger.com](http://www.smithberger.com)